

CLAD Multi-Point Casement-Section Drawings



Section Details : Operating/Stationary, Minimum 1” Jamb, Nail Fin	2
Section Details : 4 9/16” Jamb, Nail Fin	3
Section Details : 6 9/16” Jamb, Nail Fin	4
Section Details : French Casement, Minimum 1” Jamb, Nail Fin	5
Section Details : Big Bottom Rail	6
Section Details : SDL & Glazing Bead Options	7
Section Details : Mull Sections, Minimum 1” Jambs	8
Section Details : Mull Sections, Jambs Greater Than 1”	9

CLAD Multi-Point Casement

Section Details : Operating/Stationary, Minimum 1" Jamb, Nail Fin

SCALE: 3" = 1'-0"

Operating

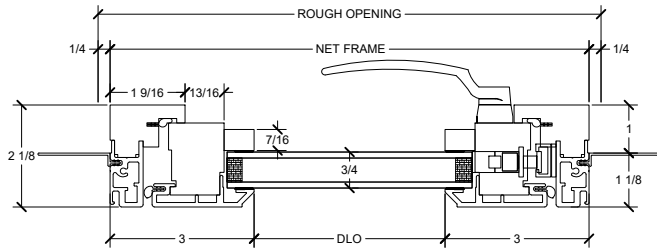

Jambs

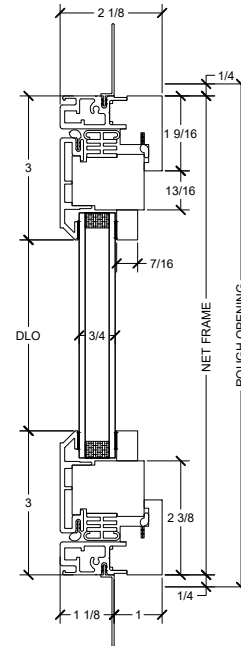

Head Jamb & Sill

Stationary

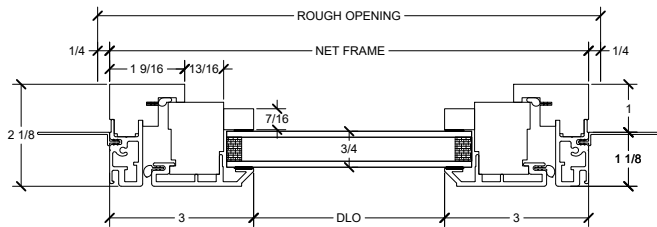

Jambs

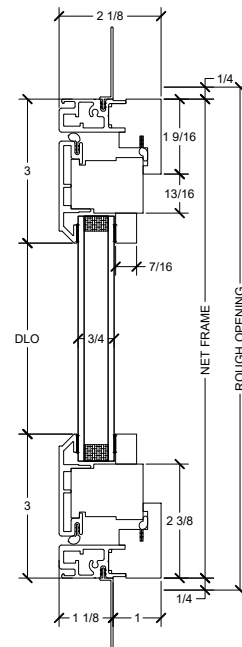

Head Jamb & Sill

CLAD Multi-Point Casement

Section Details : 4 9/16" Jamb, Nail Fin

SCALE: 3" = 1'-0"

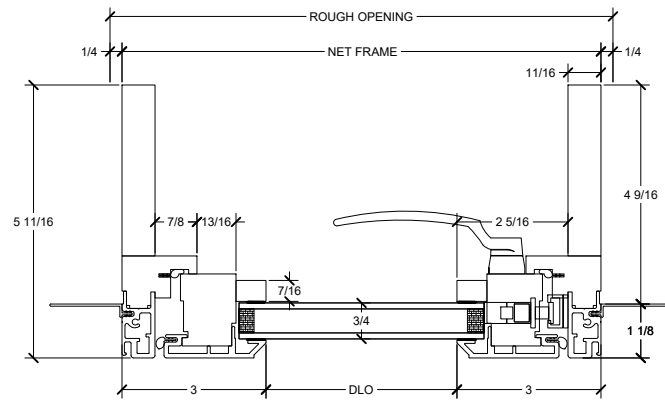

Jambs

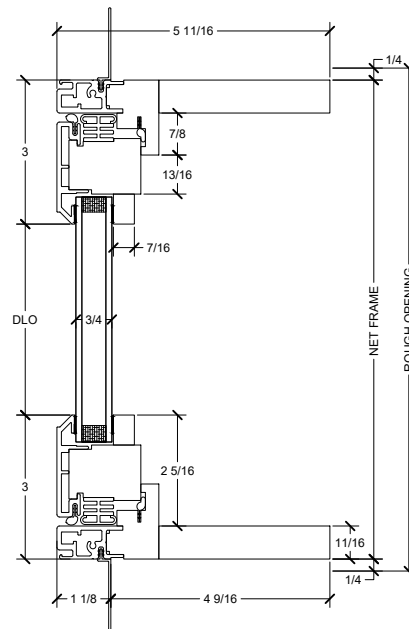

Head Jamb & Sill

CLAD Multi-Point Casement

Section Details : 6 9/16" Jamb, Nail Fin

SCALE: 3" = 1'-0"

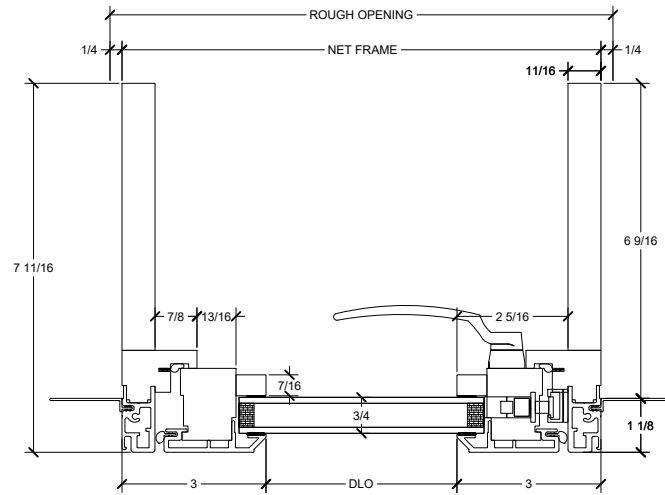

Jambs

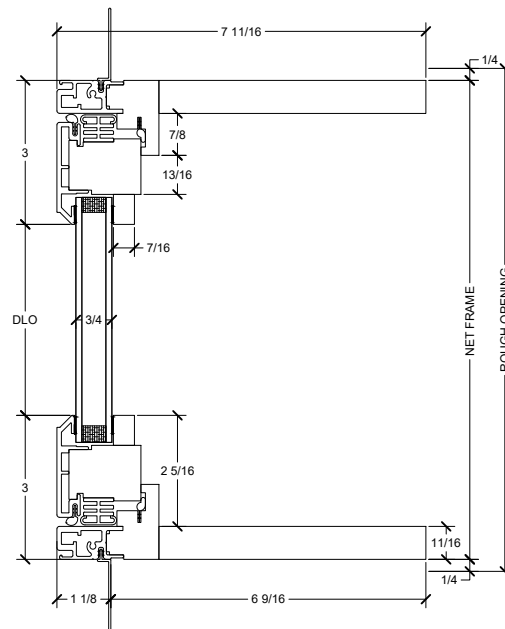

Head Jamb & Sill

CLAD Multi-Point Casement

Section Details : French Casement, Minimum 1" Jamb, Nail Fin

SCALE: 3" = 1'-0"

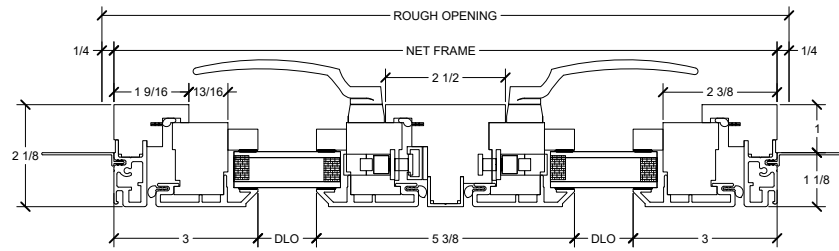

Jambs

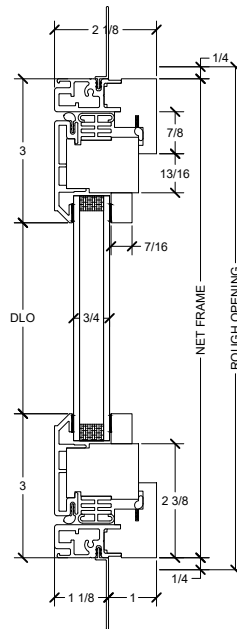

Head Jamb & Sill

CLAD Multi-Point Casement

Section Details : Big Bottom Rail

SCALE: 3" = 1'-0"

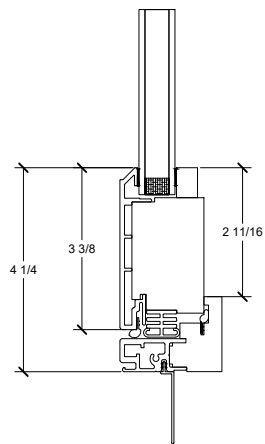

Big Bottom Rail

CLAD Multi-Point Casement

Section Details : SDL & Glaze Bead Options

SCALE: 3" = 1'-0"

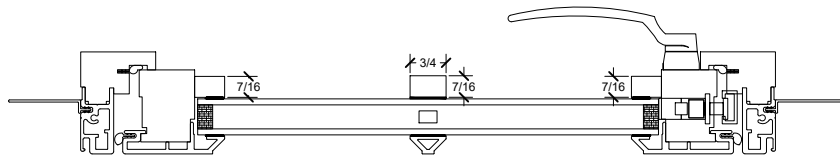

Square Detail Interior SDL—Square Interior Glaze Bead/Bevel Bead Exterior

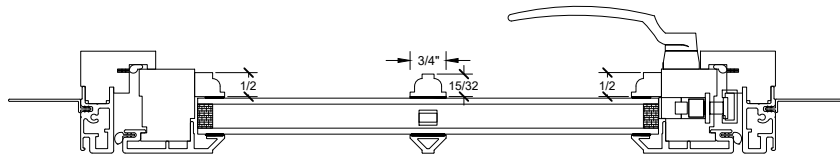

Long Bead Interior SDL—Long Bead Interior Glaze Bead/Bevel Bead Exterior

CLAD Multi-Point Casement

Section Details : Mull Sections, Minimum 1" Jamb

SCALE: 3" = 1'-0"

Mulling Clad Casement to Clad Casement

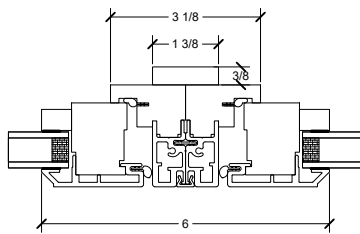

Vertical Mull

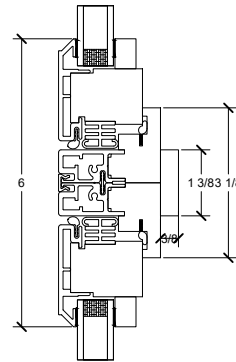

Horizontal Mull

Mulling Clad Picture (Minimum 1" Jamb) to Clad Casement (Minimum 1" Jamb)

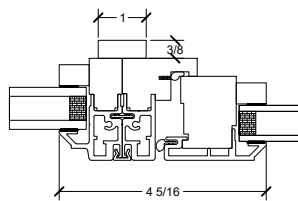

Vertical Mull

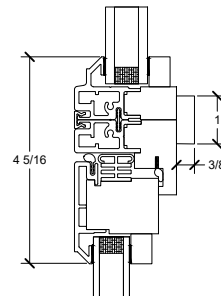

Horizontal Mull

CLAD Multi-Point Casement

Section Details : Mull Sections, Jambs Greater Than 1"

SCALE: 3" = 1'-0"

Mulling Clad Casement to Clad Casement (Jambs Greater Than 1")

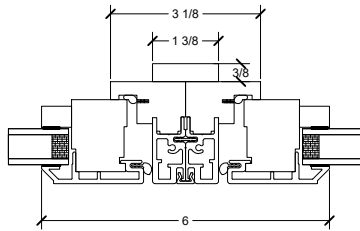

Vertical Mull

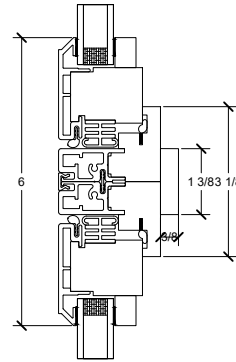

Horizontal Mull

Mulling Clad Picture to Clad Casement (Jambs Greater Than 1")

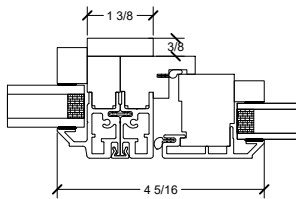

Vertical Mull

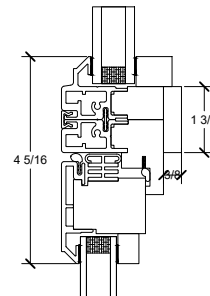

Horizontal Mull